



The Basic Guide to Winching Techniques

Every winching situation has the potential for personal injury. In order to minimize that risk, it is important that you read this Basic Guide carefully, familiarize yourself with the operation of your winch before having to use it, and be constantly safety oriented. In this Guide, we will set forth many of the basic rules of safe winch operation. However, because every winching situation is different, your constant good judgment and consistent focus on safety are of great importance.

TABLE OF CONTENTS:

Winch basics	2-3
How the winch works	4
Winch accessories & enhancements.....	5-6
Before you pull	7-9
Pulling.....	9-12
Rigging techniques.....	13-14
Putting a winch to work.....	14-15
Maintenance.....	15
The final analysis.....	15

WARN INDUSTRIES OFF-ROAD PRODUCTS

12900 S.E. Capps Road
Clackamas, OR 97015-8903 USA

Customer Service: 1-800-543-WARN
Fax: 1-503-722-3000

www.warn.com

ELECTRIC WINCH BASICS

⚠ WARNING

Never operate or install a winch without reading or understanding the operator's manual

SO, YOU HAVE YOUR WARN WINCH and you're ready to get out on the trails: climb a few boulders, splash a little mud, traverse the occasional stream. Basically, you're ready to explore the backcountry and otherwise have a great time.

Well, if you're smart enough to go prepared with the best, you're probably smart enough to know that to keep having a great time, you need to fully understand your winch and the winching operation.

That's exactly what this guide intends to do: provide you with a basic understanding of your winch and teach you the basics of proper winching

techniques. But before we get started, we must emphasize that the information in this guide is general in nature. Because no two situations are alike, it would be nearly impossible to review them all. We can, however, provide you with the general principles and techniques. Then it is up to you to take the time to analyze the situation and apply the proper technique.

Along with a little common sense, the guidelines laid out in this book can help you keep off-roading fun. Just remember to think through each situation before you act and TREAD LIGHTLY!

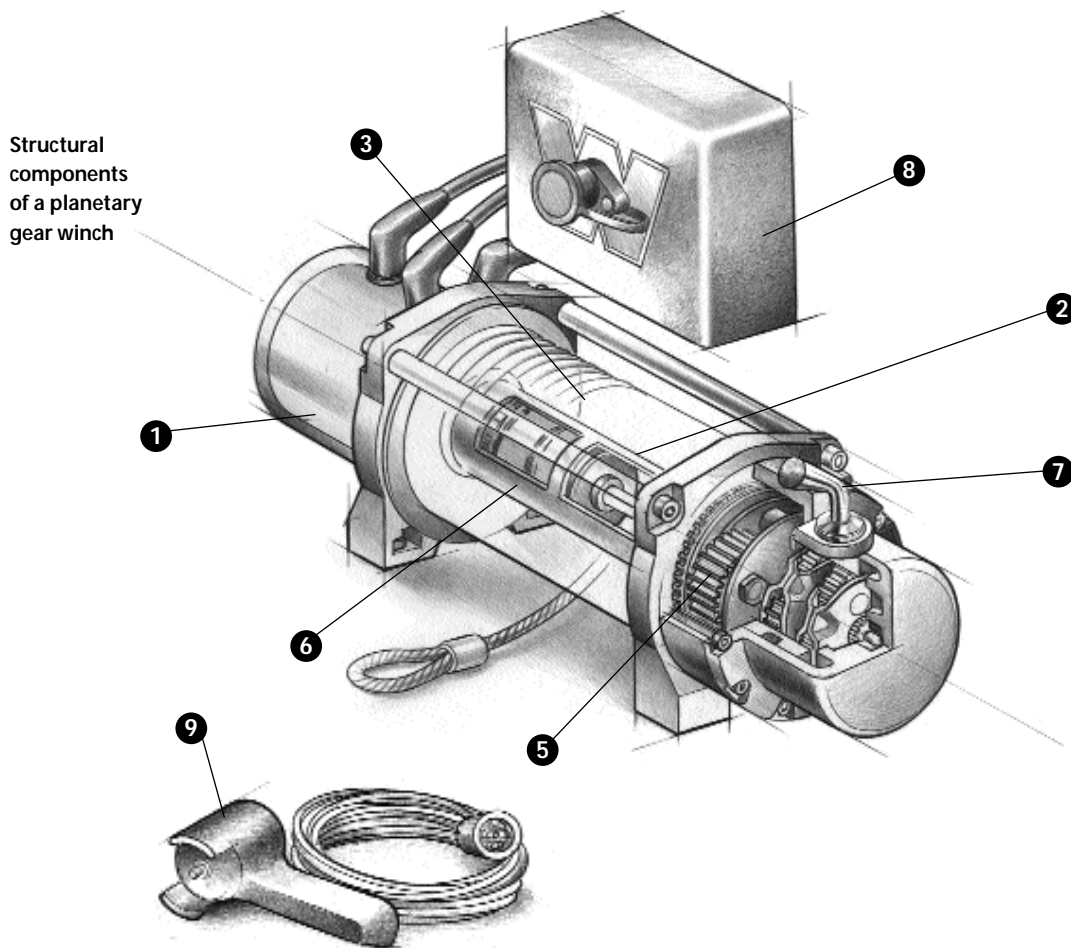

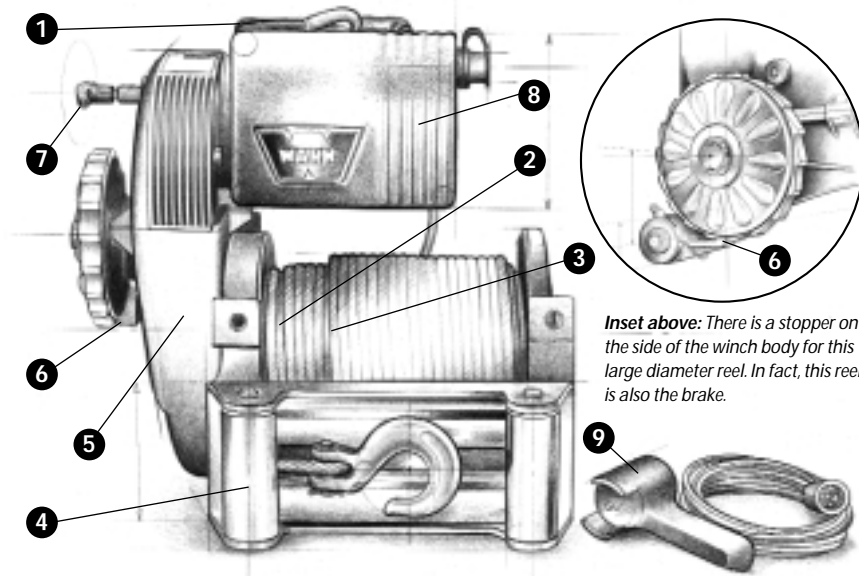

Inset above: There is a stopper on the side of the winch body for this large diameter reel. In fact, this reel is also the brake.

The 8274-50 winch has a different structure. This winch uses spur gears for reduction. Moreover, it has an automatic disc type brake on the body side.

To start, you should familiarize yourself with your Warn winch and each of its components: Practice using your winch before using it on the trail.

- 1 Motor** Typically the winch motor is powered by the vehicle's battery. The motor provides power to the gear mechanism, which turns the winch drum and winds the wire rope.
- 2 Winch Drum** The winch drum is the cylinder onto which the wire rope feeds. The drum is driven by the motor and drive train. Its direction can be changed using the remote control.
- 3 Wire Rope** The wire rope's diameter and length is determined by the winch's designed load capacity. Wrapped around the winch drum and fed through the fairlead, the wire rope is looped at the end to accept the hook's clevis pin.
- 4 Fairlead** When using the winch at an angle, the fairlead (or wire lead) acts to guide the wire rope onto the spooling drum. It prevents damage to the wire rope while it goes through the winch mount or bumper.
- 5 Gear Train** The reduction gear converts the winch motor power into a

large pulling force. The gear train design makes it possible for the winch to be lighter and more compact.

- 6 Braking System** The brake is automatically applied to the winch drum when the winch motor is stopped and there is load on the wire rope. The brake prevents the winch from paying out line, which in turn holds the vehicle in place.
- 7 Clutch** The clutch allows the operator to manually disengage the spooling drum from the gear train, enabling the drum to rotate freely (known as "freespooling"). Engaging the clutch "locks" the winch drum back onto the gear train.
- 8 Control Box** Using electrical power from the vehicle's battery, the control box solenoids relay the signals it receives from the remote control to the motor, enabling the operator to change the direction of the winch drum rotation.
- 9 Remote Control** The remote control plugs into the winch control box, allowing the operator to control the winch direction, as well as stand well clear of the wire rope while operating the winch.

△ WARNING
 Never attempt to disengage the clutch while the wire rope is under tension and never engage the clutch while the spooling drum is rotating.

HOW THE WINCH WORKS

Winch Mechanics

Now that you've familiarized yourself with your Warn winch and its components, we can begin reviewing how it works. The major advantage of an electric-powered winch is that it can provide reliable service for intermittent utility and recreational use even while the vehicle's engine is stalled — assuming, of course, that sufficient battery current is available. Your winch can operate at high amperage loads, and, for this reason, the control box uses a high amperage control system to safely handle the current flow.

It is important to understand that the longer the pull, the more the amperage draw. This creates heat, just like a hot plate, and prolonged winching without cooling the motor will damage the motor.

The winch is controlled by the hand held remote control to allow the operator to stand clear during the winching process.

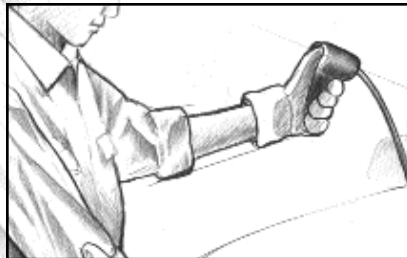

Also, if the engine is idling during winching, the battery may drain faster than it is charging. So pay close attention to your amperage gauge to make sure you aren't draining your battery too low to start your vehicle.



Control Of Your Winch

The winch is controlled by the hand held remote control to allow the operator to stand clear while controlling the winching process. The remote control provides control of the forward or reverse rotation of the spooling drum.

How the Winch Reacts to Load

Warn winches are rated at maximum pulling capacity. This occurs on the first layer of wire rope on the drum. As the layers increase, the pulling power decreases. It's the mathematics of winching. Exceeding the winch capacity could cause the winch to fail or the wire rope to break. Thinking through how you intend to use your winch now, could save you a big headache later.

In addition, you'll also want to make sure that your winch's mounting system and your vehicle's frame can accommodate the rated load of your winch.

So analyze your situation. Use your judgement to calculate how much weight you intend to pull. Calculate the gross weight and multiply by 1.5 and then do not exceed the rating of your winch or wire rope.

WINCH ACCESSORIES YOU'LL WANT TO HAVE WITH YOU

Alone, the winch is not much more than a simple tool. But when used with certain accessories and enhancements, your Warn winch can become a versatile and productive tool. In this section, we'll review several of these items. Some are vital to the safe operation of your winch, while others offer added versatility and convenience.



Gloves Wire rope, through use, will develop "barbs" which can slice skin. It is extremely important to wear protective gloves while operating the winch or handling the wire rope. Avoid loose fitting clothes or anything that could become entangled in the wire rope and other moving parts.

Hook Strap Use to hold the hook and keep fingers away from the fairlead as the wire rope is being spooled in. Winches develop tremendous pulling forces and can easily remove fingers and limbs that are placed in pinch points. Put the hook into the loop and hold the strap between the thumb and forefingers.

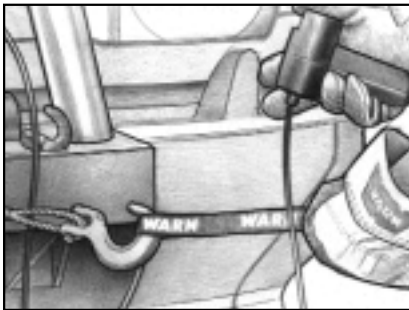

Clevis/D-Shackles The D-Shackle is a safe means for connecting the looped ends of cables, straps and snatch blocks. The shackle's pin is threaded to allow easy removal.



Snatch Block Used properly, the multi-purpose snatch block allows you to:
(1) increase your winch's pulling power; and
(2) change your pulling direction without damaging the wire rope. Proper use of the snatch block is covered in "Before You Pull!"



Choker Chain Can be used to hook-up to another vehicle or sharp objects for an anchor point. Chains, however, will damage or kill trees.

Tow Hooks Secured properly to your vehicle's frame, tow hooks provide an attachment point for wire hooks, straps, and chains.



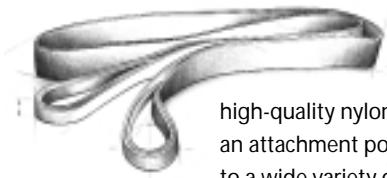

Tree Trunk Protector Typically made of tough,

high-quality nylon, it provides the operator an attachment point for the winch rope to a wide variety of anchor points and objects, as well as protect living trees.

Heavy Blanket In certain situations you may decide to throw a heavy blanket or similar object over the wire rope.

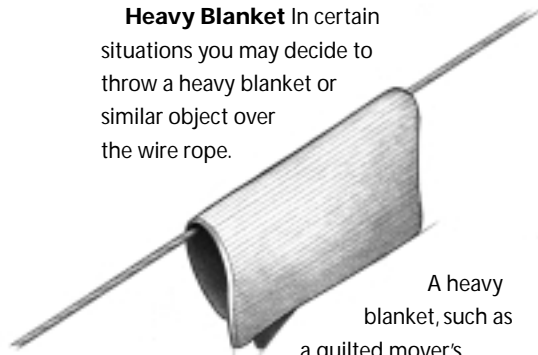

A heavy blanket, such as a quilted mover's blanket, can absorb energy should the wire rope break. Place it on the wire rope midway between the winch and the anchor point. Do this before the wire rope is put under tension. Do not approach or move the blanket once tension is applied. Do not allow it to get pulled into the fairlead. If necessary to move or remove the blanket, slack the tension on the wire rope first.

CAUTION

Never attach a recovery strap to the winch hook to increase the length of a pull. Never attempt to tow a vehicle with the recovery strap attached directly to the winch hook. Never use "bungie" straps that develop tremendous and potentially dangerous amounts of force when stretched.



Recovery Strap Never use a recovery strap in a winching operation. Because it is designed to stretch, it stores energy and could react like a rubber band should your rigging fail. Use the recovery strap to "snatch" out a stuck vehicle.

Shovels & Hand Tools Quite often during winching activities, you'll find yourself in need of some additional help. You may want to stow equipment such as a shovel, an axe, and a Hi-Lift jack near the winch to provide quick access to additional assistance when needed.

Backup Parts Important backup parts to carry for backcountry travel should include an extra screw-pin shackle, snatch block, and remote control unit. For severe and continued winch use, consider including an extra wire rope and winch hook.

Toolbox Items Items to bring along include hand wrenches, screwdrivers, pliers, and a pair of quality wire cutters to repair frayed or damaged wire rope. For light electrical work, also include automotive electrical wire and connectors, electrical tape, duct tape, mechanic's wire, a crimping tool and an extra solenoid.

Booster Cables Many roadside emergencies stem from a dead battery. To prevent exhausting your electrical source, you can install a dual battery system and a battery isolator kit. Also, it's wise to include battery booster cables and the Warn quick-connect cable system.

Battery Recommendations A fully charged conventional automotive battery with a minimum rating of 650 cold cranking amps is recommended to obtain peak performance from your winch. Make sure all electrical connections are clean and tight.

BEFORE YOU PULL

Practice using your winch before you get stuck. A real situation is no time to be learning how to use your winch.

Make sure new wire rope is stretched before it is first used. Unspool the full length of the wire rope, leaving 5 wraps on the drum. Apply at least 500 pounds of tension. You can do this by setting up an anchor point and pulling your vehicle to it on a slightly inclined, flat surface and letting the vehicle roll.

Whether you're recovering another vehicle or pulling a stump from the ground, knowing the proper winching techniques can help keep you and others around you safe. And perhaps the most important part of the winching process, regardless of the situation, is what you do before you pull.

In this section, we'll show you the basic fundamentals for effective winching. However, it is up to you to analyze the situation and make the decisions necessary for the proper use of your winch. Apply your knowledge of your winch and the basic fundamentals you've practiced and adjust your techniques to your unique situation. Some keys to remember when using your Warn winch:

1. Always take your time to assess your situation and plan your pull carefully.
2. Always take your time when using a winch.
3. Use the right equipment for your situation.
4. Always wear leather gloves and do not allow the wire rope to slide through your hands.
5. You and only you should handle the wire rope and operate the remote control switch.
5. Think safety at all times.
6. Practice. Practice and practice the steps.



Single line pull

Rigging for the Pull

The following steps describe how to recover your vehicle with rigging a single line pull. Double or multiple line rigging techniques follow the same basic steps, but use a snatch block to assist the process.

Step 1: PUT ON GLOVES.

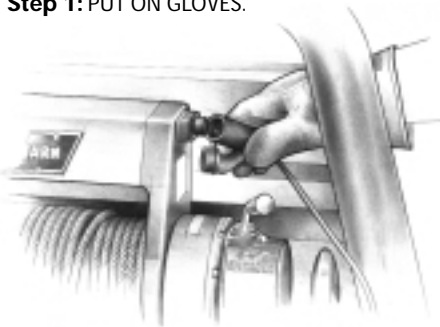

Step 2: CONNECT THE REMOTE CONTROL.

Be careful not to let the remote control cord dangle in front of the winch. If you choose to control the winch from inside your vehicle, always pass the remote through a window to avoid pinching the cord in the door. **Always disconnect the remote control when not in use.**

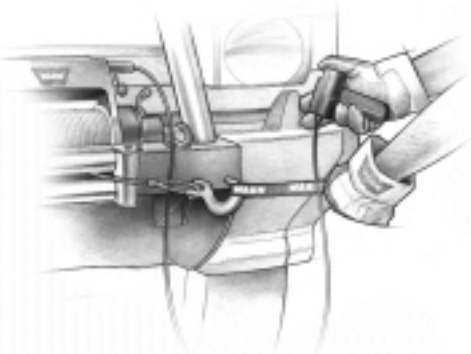

△ WARNING

Always keep hands and clothing clear of the wire rope, hook and fairlead opening during operation and when spooling.

Step 3: FREE THE WINCH HOOK.

Using the remote control, feed out a bit of the wire and then free the winch hook from its anchor point on the vehicle.

CAUTION

Never attempt to disengage the clutch while wire rope is under tension. Never engage the clutch while the drum is rotating. Always make sure the clutch is fully engaged or disengaged.



Step 4: DISENGAGE CLUTCH. To allow free spooling of the winch drum, rotate the clutch lever on the winch to Disengage. Freespooling conserves battery power.



Step 5: PULL WIRE TO ANCHOR POINT. Pull out enough wire rope to reach your anchor point. Be sure to keep a certain amount of tension in the wire. It can become twisted and overwrap when slackened, leading to wire rope damage. To prevent losing the end, hold the winch hook in the hook strap while you work.

Step 6: SECURE TO THE ANCHOR POINT. Once you've established your anchor point, secure the tree trunk protector or choker chain around the object.



HOW TO CHOOSE AN ANCHOR POINT:

A secure anchor is critical to winching operations. An anchor must be strong enough to hold while winching. Natural anchors include trees, stumps, and rocks. Hook the cable as low as possible. If no natural anchors are available, when recovering another vehicle, your vehicle becomes the anchor point. In this case, be sure to put the transmission in neutral, apply the hand brake and block its wheels to prevent your vehicle from moving.

Ideally, you'll want an anchor point that will enable you to pull straight in the direction the vehicle will move. This allows the wire rope to wind tightly and evenly onto the spooling drum. An anchor point as far away as possible will provide the winch with its greatest pulling power.

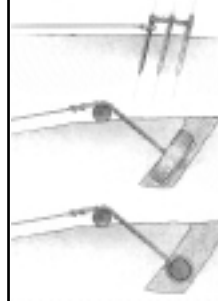

Stakes or axles, driven in at an angle and tied together.

Spare tire and rim buried deep and the chain secured through the rim.

Buried log with chain secured around the log.

CAUTION

Never winch when there are less than 5 wraps of wire rope around the winch drum.



Step 7: ATTACH THE CLEVIS/D-SHACKLE. Attach the shackle to the two ends of the strap/chain, being careful not to over tighten (tighten and back-off 1/2 turn).



Step 8: SECURE THE WINCH HOOK. While keeping the line near the ground, insert the winch hook through the D-shackle.

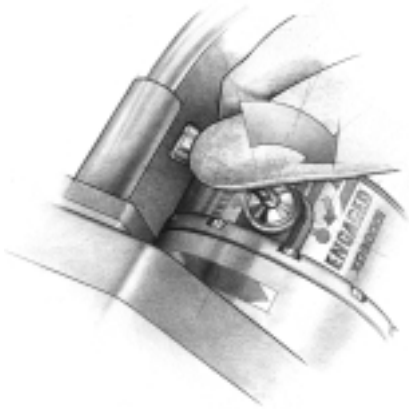

Step 9: LOCK THE CLUTCH. Lock the winch drum by rotating the clutch lever on the winch to Engage.



Step 10: PUT WIRE ROPE UNDER TENSION. Using the remote control, slowly wind the wire rope until no slack remains. Once the wire rope is under tension, stand well clear, and never step over it.

Step 11: CHECK YOUR ANCHOR. Make sure all connections are secured and free of debris before continuing with the winching procedure.

PULLING

As you probably have already noticed, there are many things to do and consider before you actually begin pulling. Think through what you're doing and you can keep yourself and those around you out of harm's way.

Operating your winch properly is so important, in fact, you should practice these techniques before having to face the distractions and stresses of a real winching situation.

△ WARNING

Never, never, never use the winch as a hoist. Never use the winch's wire rope to tow another vehicle.

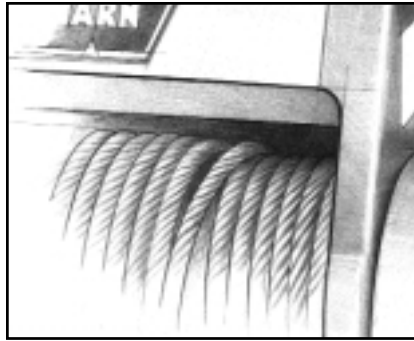

Step 12: CHECK WIRE ROPE. The wire rope should be neatly wound around the spooling drum. Improper winding can cause damage to the wire rope.

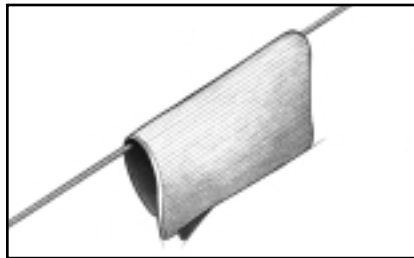

Step 13: LAY BLANKET OVER WIRE ROPE. If you decide it is necessary, throw the heavy blanket midway between the winch and the anchor point to absorb energy should the wire rope snap loose.

Step 14: MAKE YOUR INTENTIONS CLEAR. Be sure that everyone in the immediate vicinity surrounding the winching operation is completely aware of your intentions before you pull.

Declare where the spectators should not stand — *never behind or in front of the vehicle and never near the wire rope or snatch block.* Your situation may have other “no people” zones.

Establish “no people” zones:

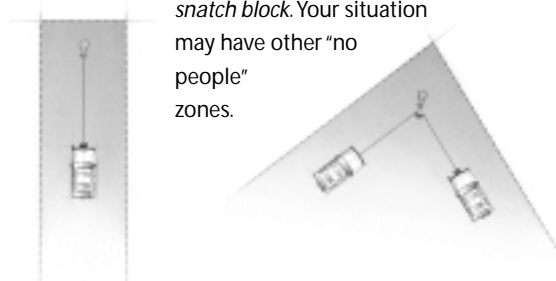

Step 15: BEGIN WINCHING. With the winching vehicle's engine on and light tension already on the wire rope, begin winching slowly and steadily. Be sure that the wire rope is winding evenly and tightly around the spooling drum. For additional assistance, the winched vehicle can be slowly driven while being pulled by the winch.

Step 16: For vehicle recovery, continue pulling until the vehicle is on stable ground. If you are able to drive the vehicle, the winching operation is complete.

Step 17: SECURE VEHICLE. Once recovery of the vehicle is complete, be sure to secure the vehicle's brakes and put the Transmission in “park” (automatic) or “low” gear for (manual) transmissions. Release tension in the wire rope.



Avoid overheating the winch motor. For extended winching, stop at reasonable intervals to allow the winch motor to cool down.

Winching hand signals

In some situations, recovery could involve two people. One driving and controlling the winch, while the other provides navigation instructions and ensures the wire rope is winding properly. You and your helper must establish clear and precise hand signals and review so everyone clearly understands. It should also be understood that if the driver controlling the winch cannot see both hands of the assistant, the winch should not be activated. Suggested signals:

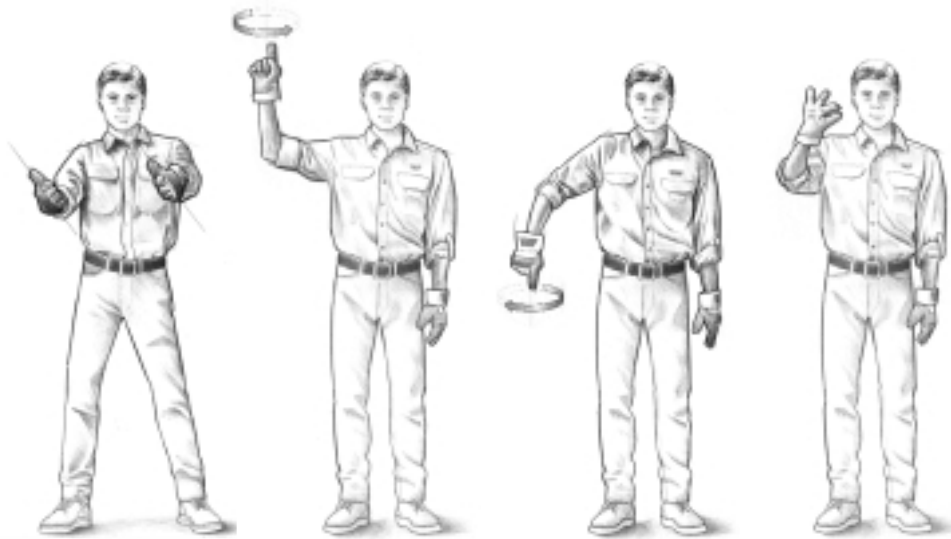

1) Direction of steering
Hold your arms out with thumbs up and tilt your hands in the direction you advise the driver to steer.

2) Power in the wire rope
Hold your forefinger in the air above your shoulder height and draw small circles in the air to indicate to wind the winch.

3) Power out the wire rope
Hold your forefinger pointing down and draw circles in the air at about waist height to indicate feeding more wire from the winch.

4) Pulse wind the wire rope
Tells the driver to wind the winch in short, quick bursts. Open and close the two fingertips until you want the winch to stop.



5) Stop the winch
Cinch fist, palm to driver, held high enough for driver to see and other arm straight out at shoulder height is the sign to stop the winch.

6) Braking
Cross your palms together to tell the driver to apply the foot brake.

7) Drive assist
Tells driver to give the tires more drive force to assist the winching process.



How to spool under no load

Arrange the remote control lead so it can not be caught in the winch. Arrange the wire rope so it will not kink or tangle when spooled. Be sure any wire rope already on the spooling drum is wound tightly and evenly layered. Tighten and straighten the layer if necessary. Keep the wire rope under light tension and spool the wire rope back onto the winch drum in even layers. Stop frequently to tighten and straighten the layers as necessary. Repeat this process until the winch hook is the same distance as the full length of the remote control from the winch. Pinch the hook between your thumb and forefinger and attach the hook strap. Hold the hook strap between the thumb and forefinger to keep tension on the wire rope. Walk the wire rope towards the fairlead, carefully spooling in the remaining wire rope by pulsing the remote control switch. Store the hook at the fairlead or tensioned to a suitable location to the side.

If you do not have the hook strap, use a length of cord or something similar. To prevent serious injury, do not put your fingers inside the hook area as you are powering in.



Step 19: REWIND WIRE ROPE. The person handling the wire rope should walk the rope in and not let it slide through the hand and control the winch at all times.

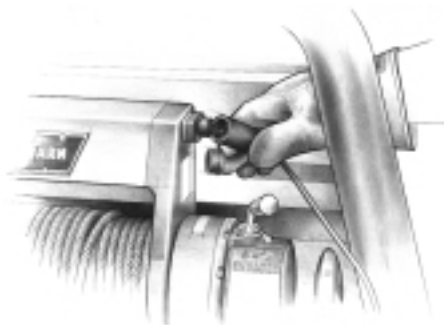

Step 20: DISCONNECT REMOTE CONTROL. Disconnect the remote control cord from the control box and store in a clean and dry place. Winching operations are now complete. Put the cap on the solenoid-housing plug in.



Step 18: DISCONNECT WIRE ROPE. Disconnect from the anchor.

RIGGING TECHNIQUES

Various winching situations will require application of other winching techniques. These could range from too little distance to achieve maximum pull using straight line rigging, simply increasing pulling power, or maintaining a straight-line pulling situation. You will have to assess what technique is correct for your situation. Think "safety" at all times.

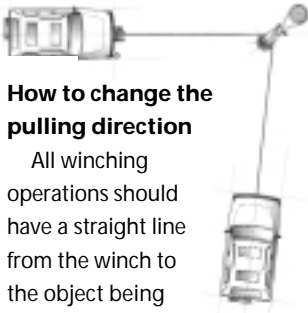

How to change the pulling direction

All winching operations should have a straight line from the winch to the object being pulled. This minimizes the wire rope collecting on one side of the drum affecting pulling efficiency and damaging wire rope. A snatch block, secured to a point directly in front of the vehicle, will enable you to change your pulling direction while still allowing the wire rope to be at 90° to wind properly onto the spooling drum.

Increasing pulling power

In some cases, you may find yourself needing more pulling power. The use of snatch blocks increases mechanical advantage and that increases your pulling power:

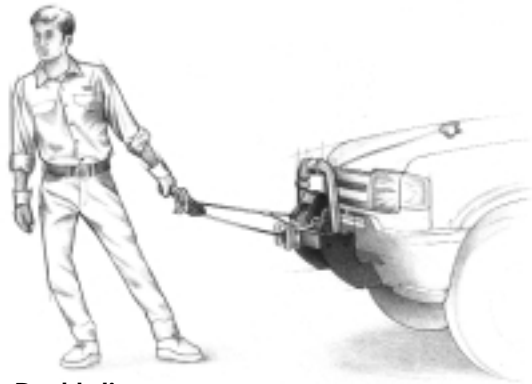
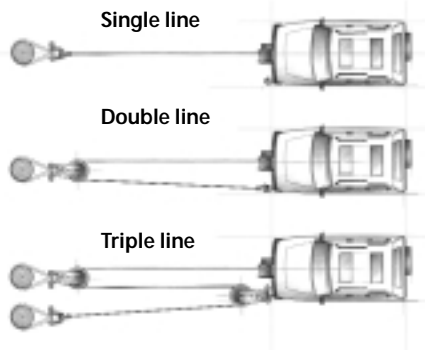

Double line

Because pulling power decreases with the number of layers of wire rope on the winch drum, you can use a snatch block to double line out more wire rope.

Start by feeding out enough wire rope to free the winch hook. Attach the hook to your vehicle's frame/tow hook and run the wire rope through a snatch block.

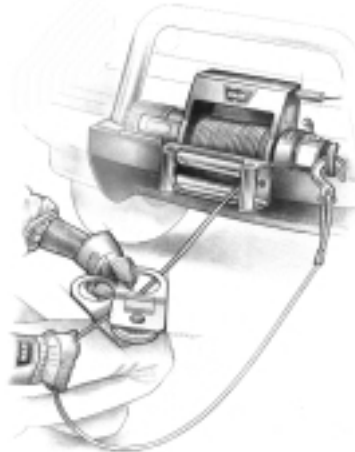

Disengage the clutch and, using the snatch block, pull out enough wire to reach your anchor point.

Secure to the anchor point with a tree trunk protector or choker chain. Attach the clevis/shackle. Attach the shackle to the two ends of the strap/chain, being careful not to over tighten (tighten and back-off 1/2 turn).

Triple Line

Use the same techniques as the Double Line. Select a robust mounting location on your vehicle for the snatch block and the screw-pin shackle. Keep a 90° angle between the winch and run the wire rope to the first anchor-point and through the snatch block. Secure rope back to the vehicle. Put the wire rope through the snatch block and secure with the screw-pin shackle on the vehicle as close to the winch as practical. Now run the wire rope to the final anchor point

Secure to the anchor point with a tree trunk protector or choker chain. Attach the clevis/shackle. Attach the shackle to the two ends of the strap/chain, being careful



not to over tighten (tighten and back-off 1/2 turn).

Secure the winch hook. While keeping the line near the ground, insert the winch hook through the screw-pin shackle. Check your anchor. Make sure all connections are secured and free of debris before continuing with the winching procedure.

PUTTING A WINCH TO WORK

Move a fallen log or tree that blocks a road with the choker chain wrapped around the tree, a snatch block and shackle. Study the situation first, but in most instances you will need to run a line through a snatch block off a tree at a 90 degree angle from the winch to pull the log to the side of the road.

Pull firewood up to the road. Use the choker chain to wrap around the log, and then use the winch to pull the log the roadside for easier cutting and loading. Use a snatch block to change the direction of the winch pull if needed.

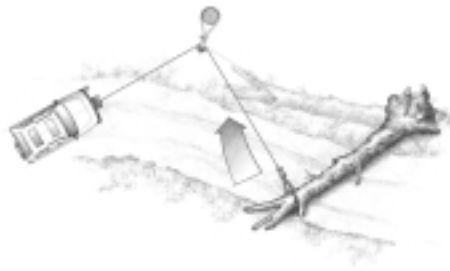

Pull out shrubs or pull down trees. Use the choker chain low around the shrub, then start pulling with the winch. The choker chain will tighten. Small shrubs can be pulled out by the roots.

On a larger tree, you can attach the choker chain high up on the trunk for leverage, then start pulling. The winch will pull the tree over and expose roots that could take hours to dig out. Slack the tension on the wire rope and cut the tree roots so the tree can be pulled loose. Use of a snatch block to change the angle of the pull to you to position the vehicle out of the way should the tree fall.

Running fence. Barb wire or cyclone fencing has to be pulled tight and held tight as you are attaching it to the vertical posts. A steel bar can be attached to the fencing material, then the winch can be used to keep tension on the fence material as you are securing it to the posts.

Reposition equipment. Any heavy equipment such as broken down tractors,

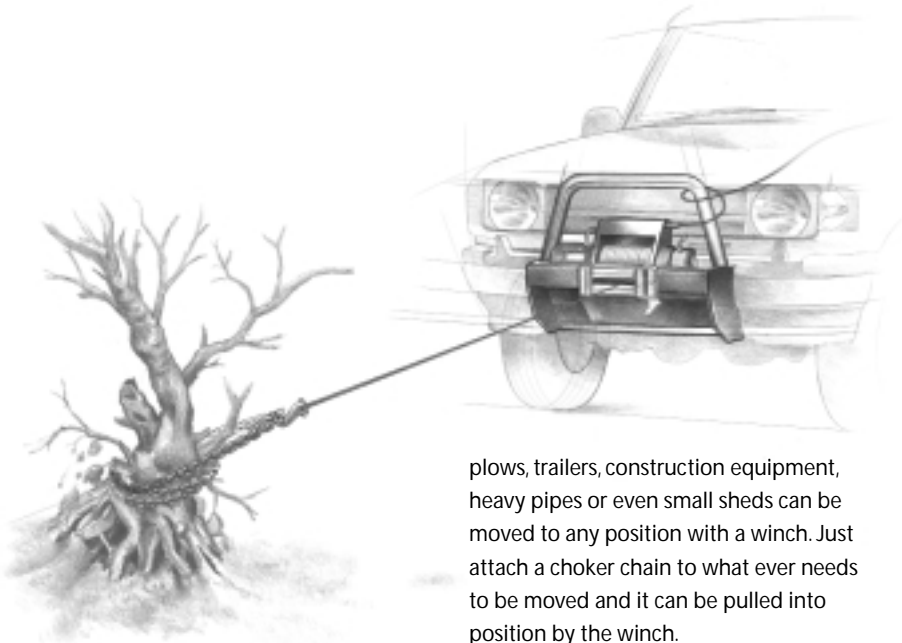

plows, trailers, construction equipment, heavy pipes or even small sheds can be moved to any position with a winch. Just attach a choker chain to what ever needs to be moved and it can be pulled into position by the winch.

MAINTENANCE

- Inspect the wire rope before and after each winching operation. If the wire rope has become kinked or frayed, the wire rope needs to be replaced. Be sure to also inspect the winch hook and hook pin for signs of wear or damage. Replace if necessary.
- Keep winch, wire rope, and remote control free from contaminants. Use a clean rag or towel to remove any dirt and debris. If necessary, unwind winch completely (leaving a minimum of 5 wraps on spooling drum), wipe clean, and rewind properly before storage. Using a light oil on the wire rope and winch hook can keep rust and corrosion from forming.
- If your winch has been submerged in water, take your winch to qualified service center to be serviced.
- Operating your winch for a long period of time places an extra burden on your vehicle's battery. Be sure to check and

maintain your battery and battery cables according to manufacturer guidelines. Also check all battery cable and electrical connections to be certain they are clean and tight fitting.

- Inspect the remote control for damage. Be sure to cap the control box fitting to prevent dirt and debris from entering the connections. Store remote control in a protected, clean, dry area.

THE FINAL ANALYSIS

The basic guide to proper winching techniques cannot cover all the possible situations in which you may need to use a winch. In the final analysis, the decisions you make will determine the final outcome. So think through each situation and each step of use. Always be mindful of your own safety and the safety of others. Pay attention and you'll have fun.